

HOUSING

Part No:KJ-4258HF-1
 Material:Nylon66 UL94-V2
 Circuits:2-6circuits available
 Insulation Resistance:1000MΩ min
 Withstand Voltage:1500V AC/minute
 Current Rating:9A AC/DC
 Voltage Rating:600V AC/DC

RoHS

ORDERING INFORMATION:

KJ-4258HF*-1**P-* (*)

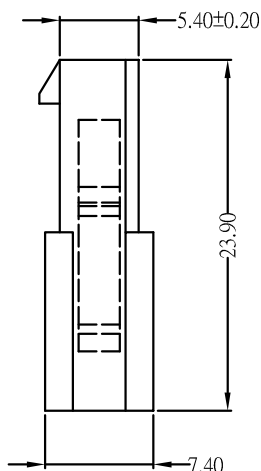
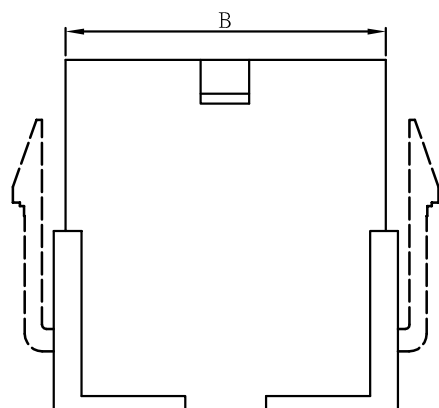
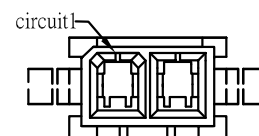
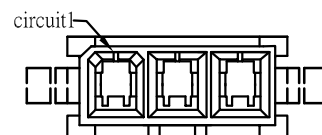
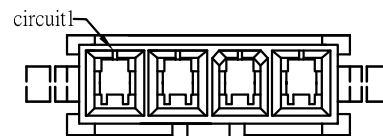
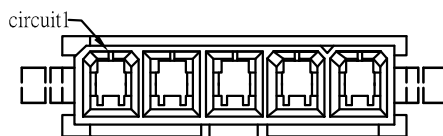
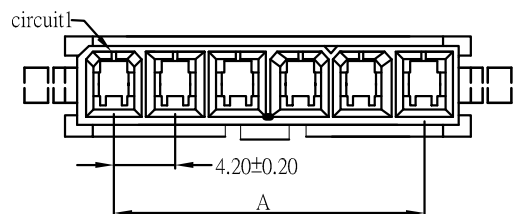
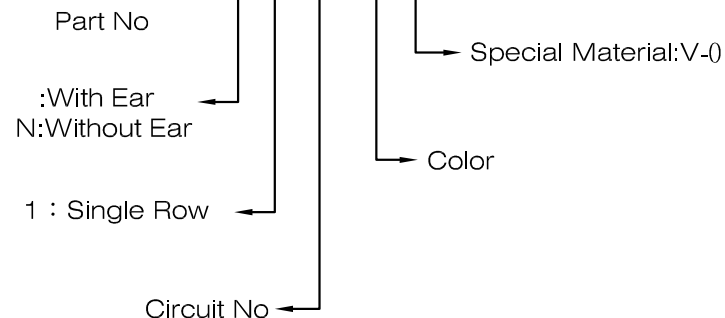

Dimensions

circuit	A	B
1*2	4.20	9.60
1*3	8.40	13.80
1*4	12.60	18.00
1*5	16.80	22.20
1*6	21.00	26.40

KJ 東莞嘉英電子廠
 JIA YING ELECTRONICS

UNIT:MM

繪圖
DRAWING:

王三星

比例 (SCALE):

2:1

DESCRIPTION: MX4.2 MINI-FIT FEMALE HOUSING SINGLE ROW

ANGLE
±2°

X.X ±0.5
 X.XX ±0.30
 X.XXX ±0.10

審核
CHECKED BY

凌輝

名稱 (TITLE):

MX4.2 Housing

PART NO:

KJ-4258HF-1

REV:A0

核准
APPROVAL BY

苗德蕙

存檔名稱 (FILE):

KJ-4258HF-1

日期 (DATE):

2008/07/08

